

# Aegis Secure Key



## User's Manual

THE LEADER IN PERSONAL STORAGE



# Apricorn Aegis Secure Key

---

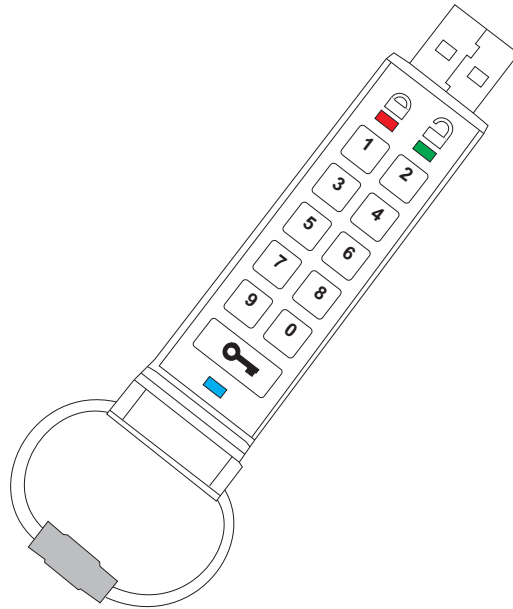

## Table of Contents

|  |          |
|--|----------|
| <b>Introduction.....</b>   | <b>2</b> |
| <b>LED Indicators.....</b>                                       | <b>2</b> |
| <b>Unlocking the Aegis Secure Key.....</b>                       | <b>3</b> |
| <b>Changing your PIN code.....</b>                               | <b>3</b> |
| <b>Resetting your Aegis Secure Key.....</b>                      | <b>4</b> |
| <b>Setup new PIN after resetting Aegis Secure Key.....</b>       | <b>4</b> |
| <b>Setup Aegis Secure Key after complete Reset.....</b>          | <b>5</b> |
| <b>Creating an Admin PIN.....</b>                                | <b>6</b> |
| <b>Unlocking the Aegis Secure Key in Admin mode.....</b>         | <b>7</b> |
| <b>Creating a User PIN after accessing Key with Admin code..</b> | <b>7</b> |
| <b>Frequently Asked Questions.....</b>                           | <b>8</b> |

# Apricorn Aegis Secure Key

## Introduction

Thank you for purchasing the Apricorn Aegis Secure Key. The Aegis Secure Key works by simply entering your desired 7-15 digit PIN directly onto the onboard keypad. The Aegis Secure Key can then be connected to any USB port on any computer. Should the Key be lost or stolen, you can rest assured that all data held on the Aegis Secure Key is safe and cannot be accessed by any unauthorized third party

We recommend that you download and print the manual first before making any changes. The manual can also be found at [www.apricorn.com](http://www.apricorn.com), then select Aegis Secure key.

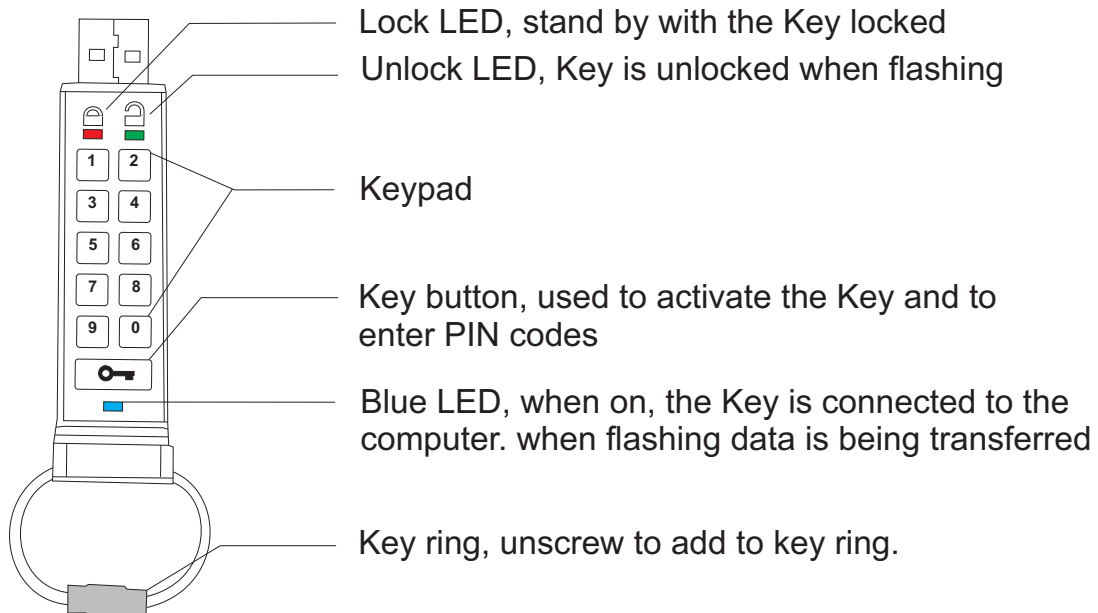

## 1. LED indicators









|  |                   |                                     |  |              |                                  |
|--|-------------------|-------------------------------------|--|--------------|----------------------------------|
|  | Blinking          | Key is unlocked, plug into USB port |  | On solid     | Key connected to USB port        |
|  | Blinking          | Key is locked                       |  | On solid     | Key does not have a User PIN     |
|  | Blinking          | Data is being transferred           |  | On solid     | Key connected with host computer |
|  | Blink alternately | Error                               |  | On solid     | Key accepting new PIN code       |
|  | Blink together    | Accepting User PIN                  |  | Double blink | Accepting Admin PIN              |
|  | Intensify         | Security self testing               |  | Double blink | Accepting Admin PIN              |



Note: The batteries are not fully charged when you receive your Aegis Secure Key. The battery should be charged prior to first use. Please plug in the Key to a powered USB port for 90 minutes to fully charge your battery

# Apricorn Aegis Secure Key

## 2. Unlocking the Aegis Secure Key

| Instructions  | LED Activity  |
|---|---|
| 1. Press the Key button  |   will blink together   |
| 2. Within 10 seconds enter the User PIN<br>(Factory default PIN: 1-1-2-2-3-3-4-4)                         |   |
| 3. Press the Key button  |  will blink for a correct PIN entry<br> will blink for an incorrect PIN entry |
| 4. Connect the Aegis Secure Key to a USB port within 30 seconds   |  will be on<br> will be on or blink for activity                              |
| 5. To lock the Aegis Secure Key, Unplug it from the USB port.   |   |

















The Aegis Secure Key is shipped with a default user PIN of 1-1-2-2-3-3-4-4. We recommend that you change the user PIN immediately for security reasons. Follow the directions under the heading “ Changing your PIN code.

## 3. Changing your PIN code

A user PIN (Personal Identification Number) can be changed to almost any number that is desired. To create your new PIN be sure to follow the instructions below

1. The new PIN is 7 to 15 digits long.
2. The new PIN can not contain all repeating numbers (3-3-3-3-3-3-3)
3. The new PIN can not have sequential numbers (1-2-3-4-5-6-7) or (7-6-5-4-3-2-1)

| Instructions   | LED Activity   |
|--|--|
| 1. Press the Key button   |   will blink together<br>(Factory default PIN: 1-1-2-2-3-3-4-4)  |
| 2. Within 10 seconds enter the User PIN and press the Key button  |  |
| 3. Press and hold the Key button  for 3 seconds                   |   will be on   |
| 4. Enter a new PIN number<br>(The number must be 7 - 15 digits)  |  |
| 5. Press the Key button  to store the new PIN                     |   will blink together  |
| 6. Re-enter the new PIN number   |  |
| 7. Press the Key button  to confirm the new PIN                   |  will blink if the new PIN is accepted and the Key is unlocked & ready to use<br>  will blink alternately if the new PIN was not accepted |



Note: If a mistake is made when changing the PIN, or the process was not complete, the KEY will retain the original PIN

















# Apricorn Aegis Secure Key

## 4. Resetting your Aegis Secure Key

In case the User PIN has been forgotten, or if you would like to delete all data stored on the key and configure a new user PIN, follow the instructions below. The reset process will clear all PINs and encryption Keys and destroy all data. This means a new User PIN will have to be defined in order to re-enable the Key. Also, since this will force the creation of a new encryption Key, the Aegis Secure Key will have to be reformatted.



**Note: By resetting the Aegis Secure Key, all data previously stored on the drive will be lost!**













| Instructions  | LED Activity  |
|---|---|
| 1. Press the Key button    |   will blink together |
| 2. Press the Key button    |  will blink  |
| 3. Press and hold the Key button and the number 2 button for 3 seconds    |   will blink together |
| 4. Enter 9 - 9 - 9 and press the Key Button     | LEDs will turn off  |
| 5. Press the Key button    |  will be on solid  |
| Note: When the  is on and solid, a new user PIN will need to be set prior to use.   |   |

## 5. Setup new PIN after resetting Aegis Secure Key

Once the Key is reset either by the method above or if the Key was locked by a brute force attack (10 unsuccessful attempts to unlock the Aegis Secure Key). A new user PIN will need to be defined.

A user PIN (Personal Identification Number) can be changed to almost any number that is desired. In order to make the Aegis Secure Key a more secure product you need to create a PIN that follows the instructions below

1. The new PIN is 7 to 15 digits long.
2. The new PIN can not contain all repeating numbers (3-3-3-3-3-3-3)
3. The new PIN can not have sequential numbers (1-2-3-4-5-6-7) or (7-6-5-4-3-2-1)

| Instructions  | LED Activity   |
|---|--|
| 1. Press the Key button for 3 seconds                  |   will be on   |
| 2. Within 10 seconds enter the new PIN<br>See the note above about acceptable PIN's   |   will be on   |
| 3. Press the Key button to save                        |   will blink together if accepted                        |
| 4. Re-enter the new PIN number & press the Key button  |  will blink if the new PIN is accepted and the Key is unlocked & ready to use   |
| 5. If the new PIN was accepted, the Green LED will be flashing. The key will be unlocked and be ready to format.                          |   will blink alternately if the new PIN was not accepted |

# Apricorn Aegis Secure Key

## 6. Setup the Aegis Secure Key with Windows after a complete reset

A complete reset of the Aegis Secure Key will erase all information and partition settings. You will need to initialize and format the Aegis Secure Key.

To initialize your Aegis Secure Key, do the following:

1. Setup and new PIN (see Page 4)
2. Unlock the Aegis Secure Key and attach to the computer.
3. Wait until the Blue LED turns on
4. Right-click My Computer, and then click Manage from the Windows desktop.
5. In the Computer Manage window, click Disk Management. In the Disk Management window, the Aegis Secure Key is recognized as a removable device in raw format
6. Do the following to make the Key recognized as a basic drive.
  - Right-click Removable Raw drive, in the blank area under the Unallocated section, and then select Format.



7. The Format window opens.

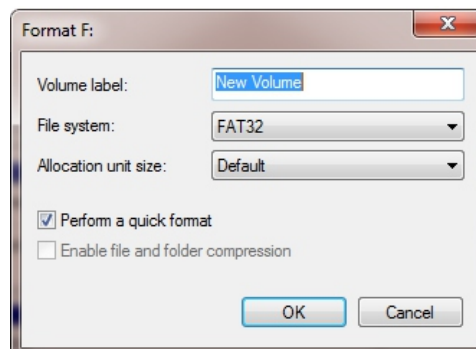

8. Select FAT32 or NTFS depending on your needs and click OK

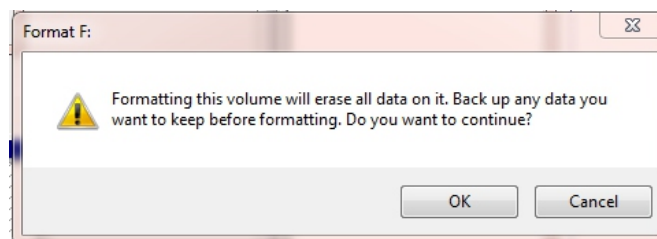

9. Click OK on the Format warning window and click OK.

10. While the Aegis Secure Key is formatting the Blue LED will be flashing.

11. When finished the Blue LED will be on solid and your Aegis Secure Key is ready for use.

# Apricorn Aegis Secure Key

## 7. Creating an Admin PIN



















*The ADMIN PIN is useful in a corporate environment where an Administrator will provide access to the Key if the User PIN is forgotten or unavailable. Individuals are strongly discouraged from using this feature as it can be cumbersome to setup and improper use can provide unintended results.*



The Aegis Secure Key can be setup with an Admin PIN. If the Admin PIN is used to access the Key the User PIN will be **erased**, and a new USER PIN will need to be created. The User data will not be erased, only the User PIN

The Admin PIN can be changed to almost any number that is desired. To create your new PIN be sure to follow the instructions below

1. The new PIN is 7 to 15 digits long.
2. The new PIN can not contain all repeating numbers (3-3-3-3-3-3)
3. The new PIN can not have sequential numbers (1-2-3-4-5-6-7) or 7-6-5-4-3-2-1











| Instructions  | LED Activity   |
|---|--|
| 1. Press the Key button    |   will blink together  |
| 2. Enter the User PIN within 10 seconds and press the Key Button   |  will blink   |
| 3. Rapidly press the Key button twice and <b>hold the Key button on the second press</b> for 4 seconds<br>  |   will be on   |
| 4. Enter a new Admin PIN number and press the Key button   |   will double blink  |
| <b>Note:</b> If the LEDs in the above step are "single blinking" then the first Key Press did not register or was not fast enough. If you continue, you will be changing the User PIN   |  |
| 5. Re-enter the new Admin PIN number and press the Key button    |  will double blink if the new PIN is accepted and the Key is unlocked<br>  Will blink alternately if the new PIN was not accepted |
| Note: if   blink alternately you will need to start over from step 3.                                       |  |



After setting up the Admin PIN you should create a User PIN. If you use the Admin PIN to access the Key the User PIN will be erased.

# Apricorn Aegis Secure Key













## 8. Unlocking the Aegis Secure Key in Admin mode

| Instructions   | LED Activity  |
|--|---|
| 1. Press the Key button 2 times<br>  |   will double blink together  |
| 2. Within 10 seconds enter the Admin PIN   |   |
| 3. Press the Key button<br>   |   will double blink if correct<br>(The user PIN is now erased)<br> will blink if incorrect |
| 4. Connect the Aegis Secure Key to a USB port within 30 seconds  |  will be on<br> will be on or blink for activity  |
| 5. To lock the Aegis Secure Key, Unplug it from the USB port.  |   |

## 9. Creating a User PIN after accessing Key with Admin code

A user PIN (Personal Identification Number) can be changed to almost any number that is desired. In order to make the Aegis Secure Key a more secure product you need to create a PIN that follows the instructions below

1. The new PIN is 7 to 15 digits long.
2. The new PIN can not contain all repeating numbers (3-3-3-3-3-3-3)
3. The new PIN can not have sequential numbers (1-2-3-4-5-6-7) or (7-6-5-4-3-2-1)

| Instructions   | LED Activity   |
|--|--|
| 1. Press the Key button for 3 seconds<br>                 |   will be on   |
| 2. Within 10 seconds enter the new PIN<br>See the note above about acceptable PIN's  |   will be on   |
| 3. Press the Key button to save<br>                       |   will blink together if accepted                        |
| 4. Re-enter the new PIN number & press the Key button<br> |  will blink if the new PIN is accepted and the Key is unlocked & ready to use   |
| 5. If the new PIN was accepted, the Green LED will be flashing. The key will be unlocked and be ready to format.                             |   will blink alternately if the new PIN was not accepted |



# Apricorn Aegis Secure Key

---

## Frequently Asked Questions

### **How to unlock the Aegis Secure Key if your battery is dead**

Your Aegis Secure Key has a built-in rechargeable battery. If the battery is fully discharged you can still continue to use the product by following the instructions below:

- a) Connect the Aegis Secure Key to a USB port on any computer
- b) While the Key is connected to the computer, enter the User or Admin PIN to unlock the Key
- c) While connected to the USB port, the internal battery will automatically charge. We recommend you keep the Key connected for approximately 1 hour to fully charge the battery.

### **If you forget your PIN**

If you forget the User and Admin PINs, there is absolutely no way of gaining access to the data stored on the Key, there are no back doors into the Key. You will need to completely reset the Aegis Secure Key by following the directions in section 4. By resetting, all data stored on the Key will be inaccessible.

When the Aegis Secure Key is reset the following occurs:

- \* A new encryption key is generated
- \* The User and Admin PIN are deleted
- \* All the data on the Key is no longer accessible
- \* A new User PIN will need to be set (section 5)
- \* The Aegis Secure Key will need to be formatted (section 6)

### **Brute force or hacking attempt protection**

If your Aegis Secure Key has 10 consecutive unsuccessful attempts to unlock, the brute force will activate and will completely reset the Key as follows:

- \* A new encryption key is generated
- \* The User and Admin PIN are deleted
- \* All the data on the Key is no longer accessible
- \* A new User PIN will need to be set (section 5)
- \* The Aegis Secure Key will need to be formatted (section 6)

# Technical Support

Apricorn provides the following helpful resources for you:

1. Apricorn's Website (<http://www.apricorn.com>)
2. E-mail us at [support@apricorn.com](mailto:support@apricorn.com)
3. Or call the Technical Support Department at **1-800-458-5448**

Apricorn's Technical Support Specialists are available from 8:00 a.m. to 5:00 p.m., Pacific Standard Time Monday through Friday

## Warranty and RMA information

### Three Year Limited Warranty:

Apricorn offers a 3-year limited warranty on the Aegis Secure Key against defects in materials and workmanship under normal use. The warranty period is effective from the date of purchase either directly from Apricorn or an authorized reseller.

### Disclaimer and terms of the warranties:

THE WARRANTY BECOMES EFFECTIVE ON THE DATE OF PURCHASE AND MUST BE VERIFIED WITH YOUR SALES RECEIPT OR INVOICE DISPLAYING THE DATE OF PRODUCT PURCHASE.

APRICORN WILL, AT NO ADDITIONAL CHARGE, REPAIR OR REPLACE DEFECTIVE PARTS WITH NEW PARTS OR SERVICEABLE USED PARTS THAT ARE EQUIVALENT TO NEW IN PERFORMANCE. ALL EXCHANGED PARTS AND PRODUCTS REPLACED UNDER THIS WARRANTY WILL BECOME THE PROPERTY OF APRICORN.

THIS WARRANTY DOES NOT EXTEND TO ANY PRODUCT NOT PURCHASED DIRECTLY FROM APRICORN OR AN AUTHORIZED RESELLER OR TO ANY PRODUCT THAT HAS BEEN DAMAGED OR RENDERED DEFECTIVE: 1. AS A RESULT OF ACCIDENT, MISUSE, NEGLIGENCE, ABUSE OR FAILURE AND/OR INABILITY TO FOLLOW THE WRITTEN INSTRUCTIONS PROVIDED IN THIS INSTRUCTION GUIDE; 2. BY THE USE OF PARTS NOT MANUFACTURED OR SOLD BY APRICORN; 3. BY MODIFICATION OF THE PRODUCT; OR 4. AS A RESULT OF SERVICE, ALTERNATION OR REPAIR BY ANYONE OTHER THAN APRICORN AND SHALL BE VOID. THIS WARRANTY DOES NOT COVER NORMAL WEAR AND TEAR.

NO OTHER WARRANTY, EITHER EXPRESS OR IMPLIED, INCLUDING ANY WARRANTY OR MERCHANTABILITY AND FITNESS FOR A PARTICULAR PURPOSE, HAS BEEN OR WILL BE MADE BY OR ON BEHALF OF APRICORN OR BY OPERATION OF LAW WITH RESPECT TO THE PRODUCT OR ITS INSTALLATION, USE, OPERATION, REPLACEMENT OR REPAIR.

APRICORN SHALL NOT BE LIABLE BY VIRTUE OF THIS WARRANTY, OR OTHERWISE, FOR ANY INCIDENTAL, SPECIAL OR CONSEQUENTIAL DAMAGE INCLUDING ANY LOSS OF DATA RESULTING FROM THE USE OR OPERATION OF THE PRODUCT, WHETHER OR NOT APRICORN WAS APPRISED OF THE POSSIBILITY OF SUCH DAMAGES.



© Apricorn, Inc. 2011. All rights reserved.  
12191 Kirkham Road  
Poway, CA, U.S.A. 92064  
1-858-513-2000 [www.apricorn.com](http://www.apricorn.com)



Aegis Secure Key is developed and Manufactured by Apricorn Inc and is based on DataLock® technology licensed from ClevX LLC